



***100-W Universal Line Input PFC
Boost Converter Using the
UCC38050***

User's Guide

EVM IMPORTANT NOTICE

Texas Instruments (TI) provides the enclosed product(s) under the following conditions:

This evaluation kit being sold by TI is intended for use for **ENGINEERING DEVELOPMENT OR EVALUATION PURPOSES ONLY** and is not considered by TI to be fit for commercial use. As such, the goods being provided may not be complete in terms of required design-, marketing-, and/or manufacturing-related protective considerations, including product safety measures typically found in the end product incorporating the goods. As a prototype, this product does not fall within the scope of the European Union directive on electromagnetic compatibility and therefore may not meet the technical requirements of the directive.

Should this evaluation kit not meet the specifications indicated in the EVM User's Guide, the kit may be returned within 30 days from the date of delivery for a full refund. THE FOREGOING WARRANTY IS THE EXCLUSIVE WARRANTY MADE BY SELLER TO BUYER AND IS IN LIEU OF ALL OTHER WARRANTIES, EXPRESSED, IMPLIED, OR STATUTORY, INCLUDING ANY WARRANTY OF MERCHANTABILITY OR FITNESS FOR ANY PARTICULAR PURPOSE.

The user assumes all responsibility and liability for proper and safe handling of the goods. Further, the user indemnifies TI from all claims arising from the handling or use of the goods. Please be aware that the products received may not be regulatory compliant or agency certified (FCC, UL, CE, etc.). Due to the open construction of the product, it is the user's responsibility to take any and all appropriate precautions with regard to electrostatic discharge.

EXCEPT TO THE EXTENT OF THE INDEMNITY SET FORTH ABOVE, NEITHER PARTY SHALL BE LIABLE TO THE OTHER FOR ANY INDIRECT, SPECIAL, INCIDENTAL, OR CONSEQUENTIAL DAMAGES.

TI currently deals with a variety of customers for products, and therefore our arrangement with the user **is not exclusive**.

TI assumes **no liability for applications assistance, customer product design, software performance, or infringement of patents or services described herein**.

Please read the EVM User's Guide and, specifically, the EVM Warnings and Restrictions notice in the EVM User's Guide prior to handling the product. This notice contains important safety information about temperatures and voltages. For further safety concerns, please contact the TI application engineer.

Persons handling the product must have electronics training and observe good laboratory practice standards.

No license is granted under any patent right or other intellectual property right of TI covering or relating to any machine, process, or combination in which such TI products or services might be or are used.

Mailing Address:

Texas Instruments
Post Office Box 655303
Dallas, Texas 75265

DYNAMIC WARNINGS AND RESTRICTIONS

It is important to operate this EVM within the maximum input voltage ranges of 85 Vac to 265 Vac.

Exceeding the specified input range may cause unexpected operation and/or irreversible damage to the EVM. If there are questions concerning the input range, please contact a TI field representative prior to connecting the input power.

Applying loads outside of the specified output range may result in unintended operation and/or possible permanent damage to the EVM. Please consult the EVM User's Guide prior to connecting any load to the EVM output. If there is uncertainty as to the load specification, please contact a TI field representative.

During normal operation, some circuit components may have case temperatures greater than 50°C. The EVM is designed to operate properly with certain components above 50°C as long as the input and output ranges are maintained. These components include but are not limited to linear regulators, switching transistors, pass transistors, and current sense resistors. These types of devices can be identified using the EVM schematic located in the EVM User's Guide. When placing measurement probes near these devices during operation, please be aware that these devices may be very warm to the touch.

Mailing Address:

Texas Instruments
Post Office Box 655303
Dallas, Texas 75265

Copyright © 2004, Texas Instruments Incorporated

100-W Universal Line Input PFC Boost Converter Using the UCC38050

Mike O'Loughlin

Power Supply Control Products

Contents

1	Introduction	4
2	Caution	4
3	Schematic	5
4	Reference Design Layout	6
5	Electrical Characteristics	6
6	Reference Design Performance	7
7	List of Materials	9

1 Introduction

The UCC38050 reference design is a 100-W offline ac-to-dc voltage converter with power factor correction (PFC). The power module was designed to show how the UCC38050 could be configured in an off line power factor corrected preregulator. The module was design to operate over a universal input range of 85 V to 265 V with a 400-V dc regulated output.

For this design to function correctly the output needs a minimum load of 25 W.

2 Caution

High-voltage levels are present on the evaluation module whenever it is energized. Proper precautions must be taken when working with this power module. The output has a large energy storage capacitor and must be completely discharged before the module can be handled. Serious injury can occur if proper safety precautions are not followed.

3 Schematic

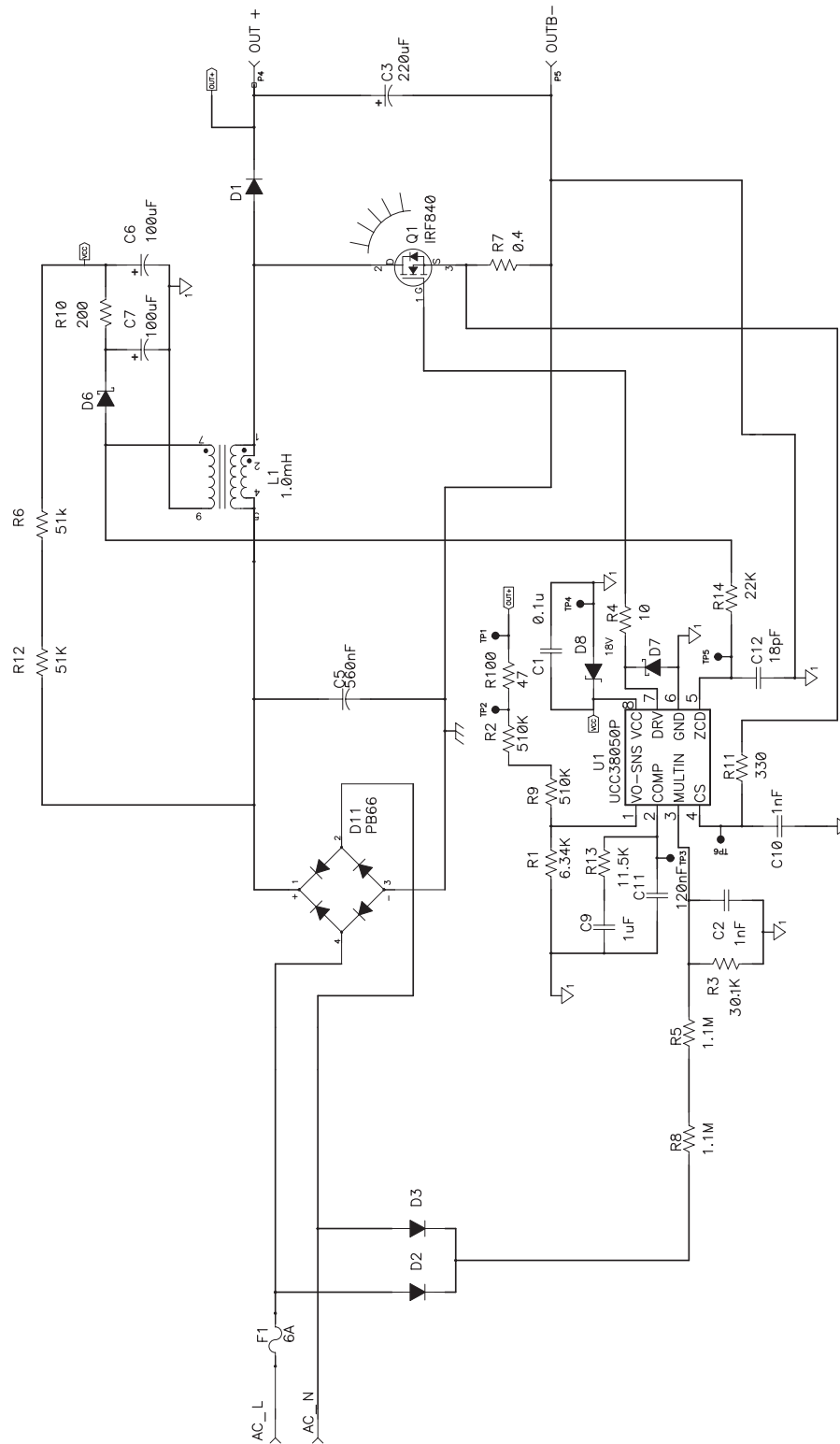

During normal operation, some circuit components may have voltages in excess of 75 V dc and 85 V ac.

4 Reference Design Layout

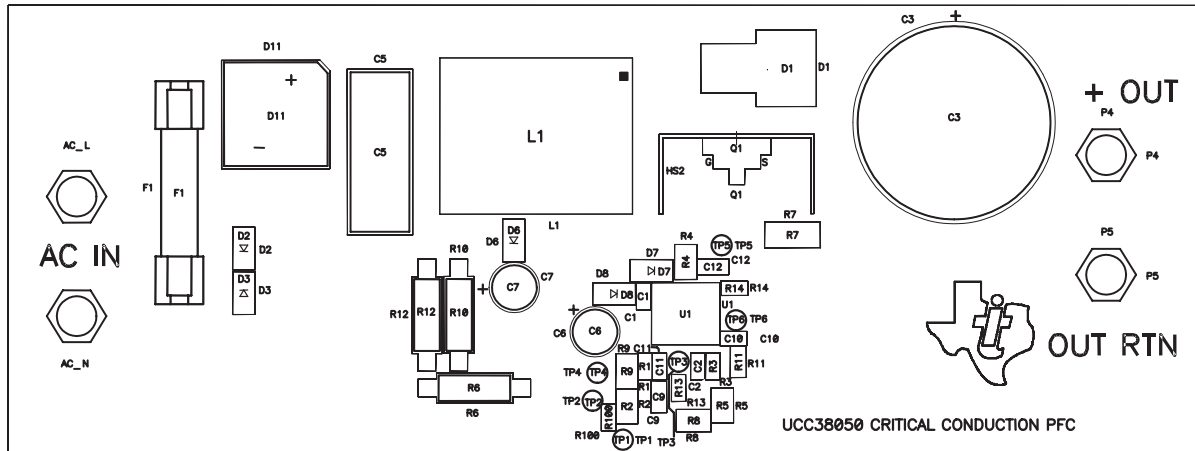

5 Electrical Characteristics

	MIN	TYP	MAX	UNITS
V_{IN}	85		265	V_{RMS}
Output	375	400	425	V
Output Power	25		100	W
Output Ripple			10	V

6 Reference Design Performance

The following figures show the reference design's performance.

Note: To achieve these results requires a 560- μ H differential mode EMI filter. The data was taken with an ac source to achieve reliable results. If a variable autotransfer, (VARIAC), ac source is used the performance of the converter will look better than these results do to the high inductance of the VARIAC.

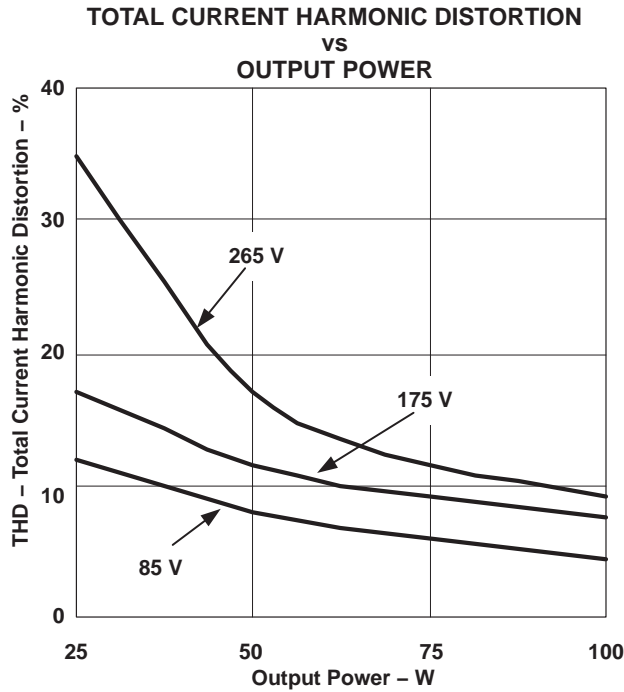

Figure 1

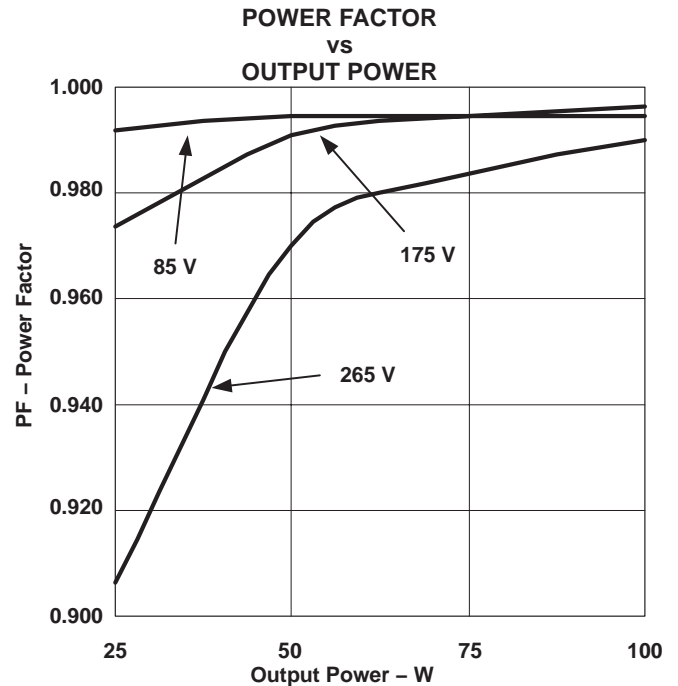

Figure 2

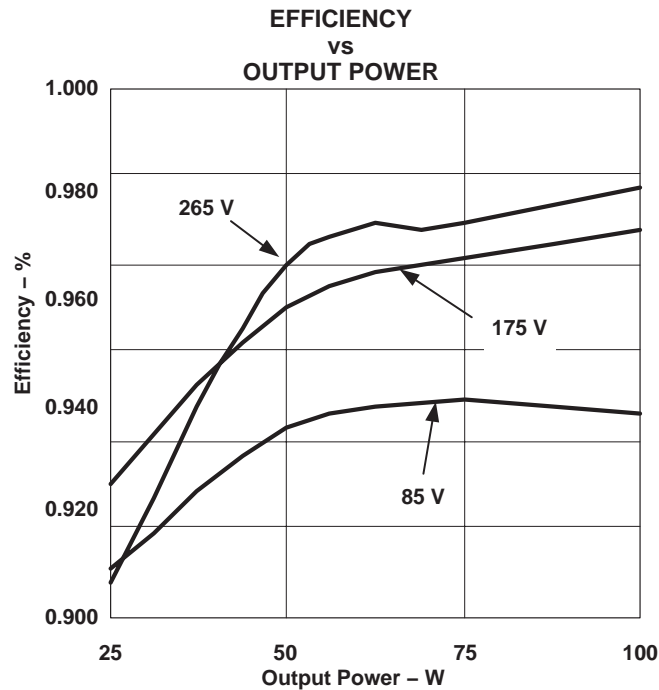
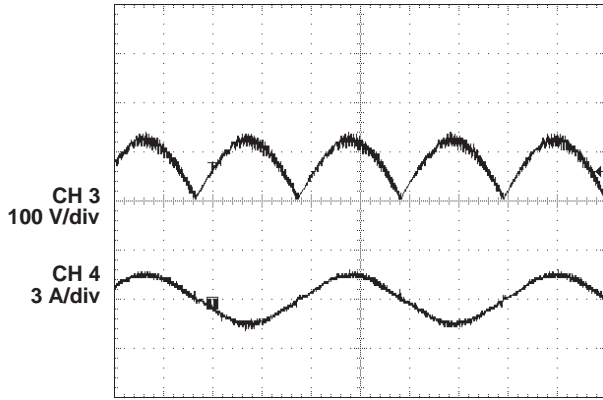

Figure 3

The following graphs show the input current and rectified line for the power module.

- Channel 3 = Rectified Line Voltage
- Channel 4 = Power Module Input Current

$V_{IN} = 85 \text{ V}, P_{OUT} = 100 \text{ W}$



t - Time - 4 ms/div

Figure 4

$V_{IN} = 265 \text{ V}, P_{OUT} = 100 \text{ W}$

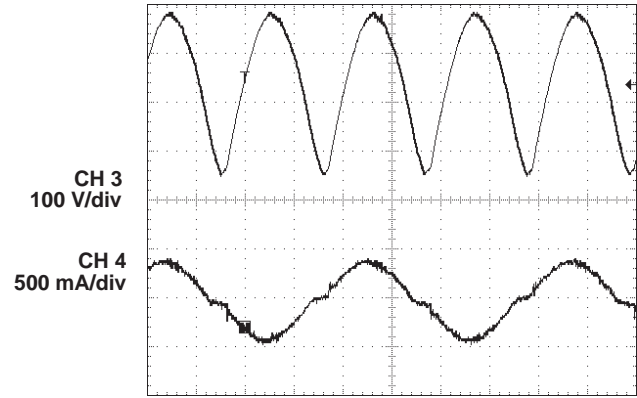

t - Time - 4 ms/div

Figure 5

$V_{IN} = 85 \text{ V}, P_{OUT} = 25 \text{ W}$

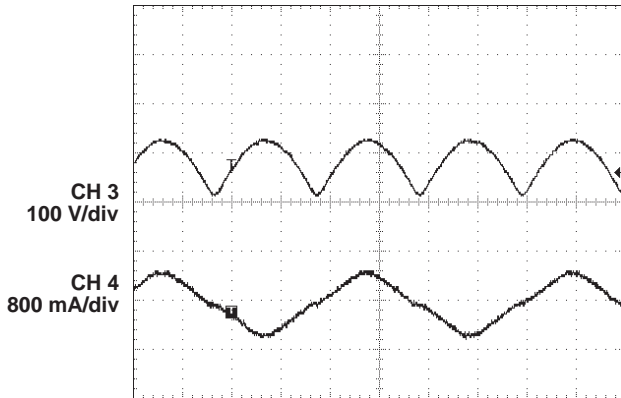

t - Time - 4 ms/div

Figure 6

$V_{IN} = 265 \text{ V}, P_{OUT} = 25 \text{ W}$

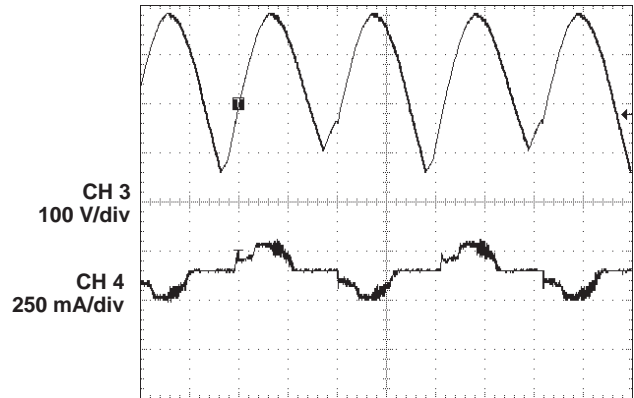

t - Time - 4 ms/div

Figure 7

7 List of Materials

	Reference	Qty	Description	Manufacturer	Part Number
Capacitor	C1	1	Ceramic, 100 nF 50 V	Yageo America	0805CG104J9B200
	C10, C2	1	Ceramic, 1000 PF 50 V	Yageo America	0805CG102J9B200
	C11	1	Ceramic, 20 nF 25 V	Panasonic	ECJ-2YB1E124K
	C12	1	Ceramic, 18 PF 50 V NPO 1206	Yageo America	1206CG180J9B200
	C3	1	Elec, 220 μ F, 450 V	Panasonic	ECO-S2WB221DA
	C5	1	Metal polypro, 0.56 μ F 400 V	Panasonic	ECW-F4564JB
	C6,C7	2	Elec, 100 μ F, 35 V	Panasonic	EEU-FC1V101
	C9	1	Ceramic, 1 μ F 16 V	Yageo America	12062R105K7BBOD
Rectifier	D2, D3	2	Standard, 1.5 A, 600 V	Vishay	BYG10J
Diode	D1	1	Hexfred, 600 V, 8 A, D2PAK	International Rectifier	HFA08TB60STRR
Rectifier	D6	1	Schottky, 1.5 A, 90 V	Vishay	BYS11-90
Diode	D7	1	Schottky, 1.5 A, 25 V	Vishay	BYS10-25
	D8	1	Zener SMD 18 V, 1 W SMA	Diodes Inc	SMAZ18-13
Rectifier	D11	1	Bridge, 6 A, 600 V	Diodes Inc	PB66
Fuse Clip	F1	1	Glass Fast Acting *Cartridge Type, 6 A, 250 V, 3 AG 1.25"x.25"	Littlefuse	312 006
	FH1, FH2	2	3 AG, for 1.25"x.25"	Cooper Electronic Technologies	1A1907-06
Heat Sink	HS1	1	TO-220	AVVID	593002 B 0 00 00
Inductor	L1	1	Coupled 12:1, 1 mH	Cooper Electronic Technologies	CTX16-15954
HEX/MOS	Q1	1	N-Channel, 500 A, 8 A, TO-220AB	International Rectifier	IRF840
Resistor	R1	1	SMD, 6.34 k Ω , 1/8 W 1%	Yageo America	9C08052A6341FKHFT
	R100	1	47 Ω , 1/10 W	Panasonic	ERJ-6GEYJ470V
	R10	1	200 Ω , 1 W	Huntington Electric Inc.	ALSR-1-200-1%
	R11	1	SMD, 330 Ω 1/4 W 1%	Yageo America	9C12063A3300FKHFT
	R14	1	SMD, 22.0 k Ω , 1/8 W, 1%	Yageo America	9C08052A2202FKHFT
	R4	1	SMD, 10.0 Ω 1/4 W, 1%	Susumu Co Ltd	RL1220S-100-F
	R13	1	SMD, 11.5 k Ω 1/8 W, 1%	BC Components	23122567H53
	R2, R9	2	SMD, 510 k Ω , 1/4 W, 1%	Yageo America	9C12063A5103FKHFT
	R3	1	SMD, 30.1 k Ω , 1/8 W, 1%	Std.	Std.
	R6,R12	2	51 k Ω , 1 W, 5%	BC Components	5073NW51K00J12AFX
	R7	1	Power metal strip, 0.4 Ω , 1 W 1%	Std.	Std.
	R8,R5	2	1.1 M Ω 1/4 W, 5%	Panasonic	8GEYJ115V
		U1	1	Critical conduction PFC controller	Texas Instruments
Screw	X1 @ Q1	1	Pan head #4-40 X 7/16 (steel)		
Nut	X2 @ Q1	1	#4X40 (steel)		
Washer	X3 @ Q1	1	Nylon shoulder, #4		
	X4 @ Q1	1	Flat #4 (steel)		
	X5 @ Q1	1	Split lock #4 (steel)		
Thermal Pad	X6 @ Q1	1	Silicon TO220	BERQUIST	SP900S-58

NOTE: The values of these components are to be determined by the user in accordance with the application requirements.

IMPORTANT NOTICE

Texas Instruments Incorporated and its subsidiaries (TI) reserve the right to make corrections, modifications, enhancements, improvements, and other changes to its products and services at any time and to discontinue any product or service without notice. Customers should obtain the latest relevant information before placing orders and should verify that such information is current and complete. All products are sold subject to TI's terms and conditions of sale supplied at the time of order acknowledgment.

TI warrants performance of its hardware products to the specifications applicable at the time of sale in accordance with TI's standard warranty. Testing and other quality control techniques are used to the extent TI deems necessary to support this warranty. Except where mandated by government requirements, testing of all parameters of each product is not necessarily performed.

TI assumes no liability for applications assistance or customer product design. Customers are responsible for their products and applications using TI components. To minimize the risks associated with customer products and applications, customers should provide adequate design and operating safeguards.

TI does not warrant or represent that any license, either express or implied, is granted under any TI patent right, copyright, mask work right, or other TI intellectual property right relating to any combination, machine, or process in which TI products or services are used. Information published by TI regarding third-party products or services does not constitute a license from TI to use such products or services or a warranty or endorsement thereof. Use of such information may require a license from a third party under the patents or other intellectual property of the third party, or a license from TI under the patents or other intellectual property of TI.

Reproduction of information in TI data books or data sheets is permissible only if reproduction is without alteration and is accompanied by all associated warranties, conditions, limitations, and notices. Reproduction of this information with alteration is an unfair and deceptive business practice. TI is not responsible or liable for such altered documentation.

Resale of TI products or services with statements different from or beyond the parameters stated by TI for that product or service voids all express and any implied warranties for the associated TI product or service and is an unfair and deceptive business practice. TI is not responsible or liable for any such statements.

Following are URLs where you can obtain information on other Texas Instruments products and application solutions:

Products		Applications	
Amplifiers	amplifier.ti.com	Audio	www.ti.com/audio
Data Converters	dataconverter.ti.com	Automotive	www.ti.com/automotive
DSP	dsp.ti.com	Broadband	www.ti.com/broadband
Interface	interface.ti.com	Digital Control	www.ti.com/digitalcontrol
Logic	logic.ti.com	Military	www.ti.com/military
Power Mgmt	power.ti.com	Optical Networking	www.ti.com/opticalnetwork
Microcontrollers	microcontroller.ti.com	Security	www.ti.com/security
		Telephony	www.ti.com/telephony
		Video & Imaging	www.ti.com/video
		Wireless	www.ti.com/wireless

Mailing Address: Texas Instruments
Post Office Box 655303 Dallas, Texas 75265